

home cinema projector series

**Action!**  
**model three 1080**

1080p resolution

up to 7500 :1 contrast ratio

DuArch™ technology

RealColor featuring BrilliantColor™

 **projectiondesign**  
*model three 1080*



## Reference grade 1080p DLP™ home cinema

The projectiondesign Action! model three 1080 is the world's highest performance true HDTV single chip DLP™ front projector. Showing true, uncompressed, and unaltered 1920 x 1080 resolution HDTV, and with its unique calibration and configuration possibilities, it is the perfect choice for high end home cinema installations.

“the picture looks simply sumptuous, as rich and lustrous as film”

*What HiFi Sound and Vision, August 2006*

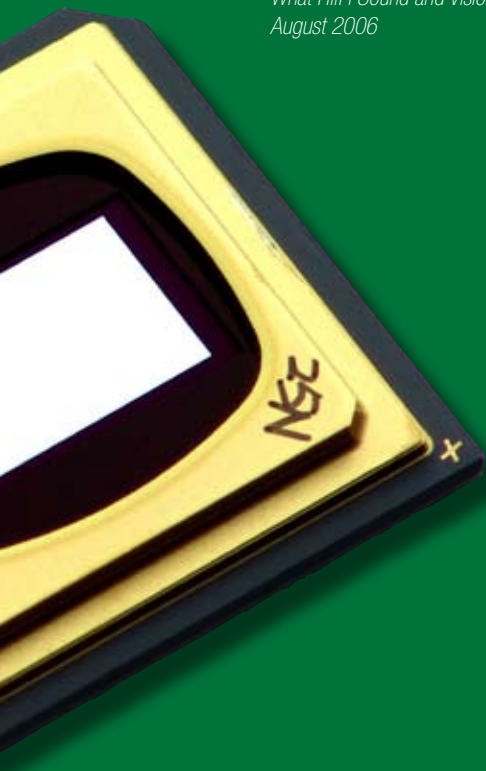

### Full HD – 1080p resolution

The projectiondesign Action! model three 1080 shows true 1920x1080 HDTV, without compromising quality in any way. Designed to provide the ultimate home cinema experience, it utilises the new 0.95" 1080p DC3™ DMD™ (Digital Micromirror Device™) from Texas Instruments®, our proprietary optical design, and features broadcast quality video processing. 1080p gives hugely improved image quality and more lifelike images through more detail and better dynamics. With a given screen size, the Action! model three 1080 reproduces up to six times the detail of regular SDTV material. An increase in image quality everyone can appreciate!

### DLP™ technology for best quality picture

DLP™ technology provides the highest possible image quality of any digital display. Its unique combination of high brightness and contrast, and vivid, natural colours, are perfect for the most demanding movies. Unmatched low level resolution provides a massive amount of details that are lost with other technologies – details that are vital for the ultimate movie experience. In addition, DLP™ technology has unmatched reliability. Independent testing shows it is the most reliable of any digital projector technology. Where LCD and LCoS variants like SXRD and D-ILA degrade over time, DLP™ is unaffected by use, and stands perfect for thousands and thousands of hours.

### Perfect colours with RealColor

All Action! model three 1080 projectors are uniquely characterised and calibrated during manufacturing. Unique optical performance values are recorded and matched with the electronics processing, in order to secure perfect on-site calibration. RealColor enables near perfect calibration out of the box.

### BrilliantColor™ changes what you see

The Action! model three 1080 features the new BrilliantColor™ processing by Texas Instruments®. Revolutionary in the way colours are processed and displayed, BrilliantColor™ dramatically increases colour saturation and rendering when needed. With



emphasis on displaying colours found in natural scenes and pictures, image quality is dramatically increased over any other competing technology, and rivals that of analogue film!

### Pure signal processing

At projectiondesign we understand the desire to achieve the purest possible signal processing. Our unique Uniboard™ technology gathers all vital signal processing on a single board, thus realising short signal paths, balanced topologies, and a noise free



video signal. In addition, all electronics boards use gold plated signal paths, separate ground layers, and separately regulated power supplies, all for the same purpose of achieving signal purity.





### Patented DuArch™ optical block

The Action! model three 1080 features our patented (US Pat. #7,033,056B2) DuArch™ optical block, with dual colour wheels, lamps, and light formatters. DuArch™ creates an enormously powerful optical base design, and provides a very large headroom in which to display the image. Similar to a large power amplifier that never runs out of steam, the Action!

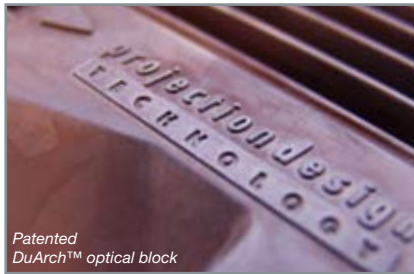

model three 1080 will never be struggling, no matter what image size you chose. With a continuously adjustable light output, it is equally at home with a 200" screens as it is with an 84" model.

### Ultra high precision optics

High precision optics are used to ensure perfect image quality. Made entirely from Low Dispersion glass, and employing aspherical lens elements, the range of six different projection lenses, from as wide as 0.79 : 1 all the way up to 6.5 : 1, all feature extremely low distortion, as well as negligible colour aberration, as they provide extremely high resolution.

All lenses feature both horizontal and vertical lens shift for distortion free installations in a variety of settings.

### Broadcast quality video processing

The Action! model three 1080 comes standard with the Crystalialo II VPS-3300 video processor. Featuring VXP™ by Gennum and DCDi™ processing by Faroujda®, it provides a perfect platform for the best possible image. Features include 4 HDMI inputs, optional HD-SDI and IEEE1394 inputs, as well as a whole range of analogue inputs. Its high build quality, and ability to control the Action! model three 1080 with a single, backlit, remote control, makes it a seamless integrator unit with the projector. If desired, the model three 1080 can be used without it, providing a true transparent, non processing interface to the DMD™ imager. It is as pure and unprocessed as it gets.

### Control and command

The Action! model three 1080 is AMX in concert compliant, which means it can be integrated into large control and command systems with ease, using already available drivers and command sets. For simpler installations, connecting an RS232 lead between the Crystalialo II and the projector enables easy operation and control using the supplied Crystalialo II remote control, for a single, seamless system!



The Crystalialo II video processor (VPS-3300) is delivered standard with the Action! model three 1080. The optional VPS-3800 (pictured above) offers a built-in hardware decoding media player, as well as HD-SDI and IEEE 1394 inputs.

### True optical contrast

The Action! model three 1080 displays video with a true optical contrast ratio of up to 7500 : 1. An advanced, and continuously adjustable optical iris sets light output and contrast ratio. That means no artificial increase of the specification through use of dynamic light output. The benefit of this system is that the image can contain the whitest whites and the blackest blacks at any one time – even in the same frame. Where other projectors can only show highlighted or dark scenes -- with a delay when switching between them, the Action! model three 1080 has no delays, and full contrast available at all times.

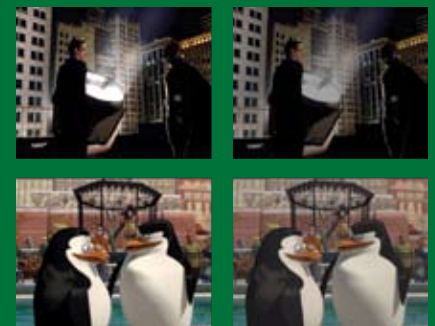
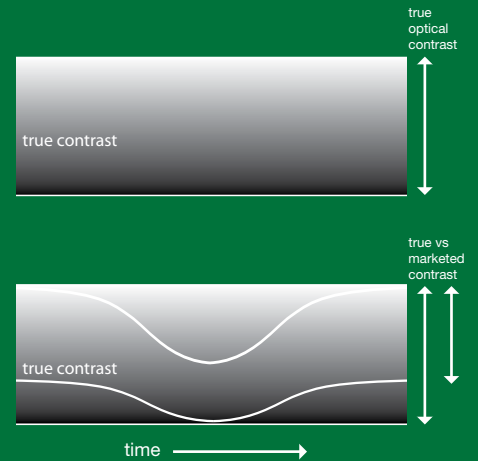

Top: Intensive white and deep black in the same picture with true optical contrast - deep black, but reduced whites with dynamic contrast.

Bottom: Deep black and intensive highs with true optical contrast - flat and compressed dynamics with dynamic contrast.

### High performance single link digital interface

The Action! model three 1080 connects to digital sources using a totally unique concept and technology. A self adapting digital line driver enables use of standard, high gauge digital cables without loss of quality. No special design interface cable is required, and lengths up to 30 meters are easily manageable.

The self adapting nature of the interface eases installation. There is no manual balancing or equalisation needed, and cables can be selected at a personal preference. Everything is just plug and play. The digital cable interface supports 10-bit HDMI video, but uses DVI connectors for mechanical superiority. In addition to the DVI cable, an RS232 cable is required for control.

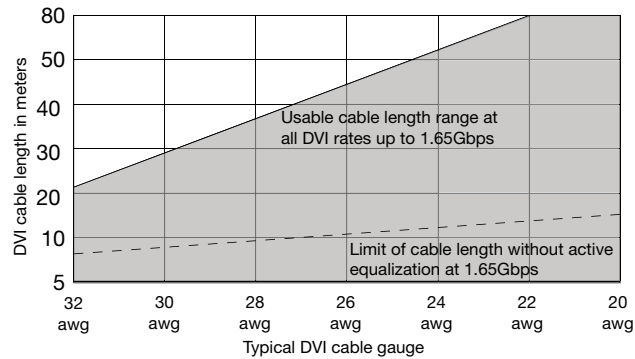

### Wide range of projection lenses

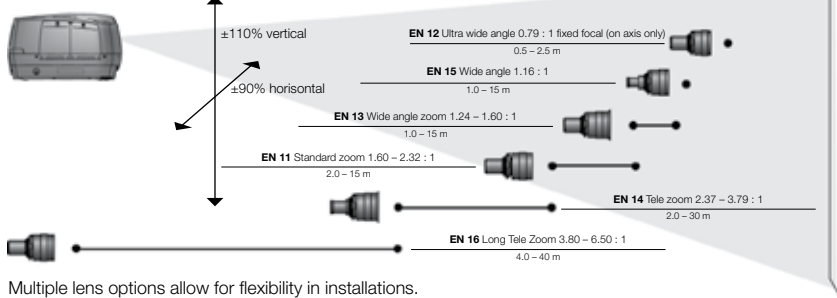

### Available versions

	silver	black
Action! model three 1080 projector unit	101-0134-14	101-0134-08
crystalio II VPS3300 video processor	302-0017-14	302-00xx-08
crystalio II VPS3800 video processor	302-0018-14	302-0018-08

Lenses available separately, see chart and specifications above.

### technical specifications

projector		Action! model three 1080	
display		full 1080p HD DLP™ home cinema projector	
technology concept	0.95" 1080p DMD™ with DarkChip3™ sealed, all-glass lens shift optical design patented DuArch™ optical architecture		
resolution	1920 x 1080 pixels		
brightness	adjustable: 500 – 2500 ANSI lumens		
contrast ratio	up to 7500 : 1 (true optical)		
colour wheels	2x RGBRGBNDG, 5x speed		
connectivity, projector unit		1080p, 48, 50, 59.94, 60 Hz	
		1x RJ45 TCP/IP network port	
		2x RS232 9-pin DSUB (in/out)	
connectivity, crystalio II processor unit		up to 1920x1200@60Hz, pixel perfect 1920x1080 at 24p, 30p, 50i/p, 59,94i, 60p	
		up to 1920 x 1080 pixels	
		SD and ED video	
		full audio switching with built in audio delay	
optics			
ultra wide angle lens	0.79 : 1	EN12 (503-0057-00)	
wide angle lens	1.16 : 1	EN15 (503-0060-00)	
wide angle zoom lens	1.24 - 1.60 : 1	EN13 (503-0058-00)	
standard zoom lens	1.60 - 2.32 : 1	EN11 (503-0056-00)	
short tele zoom lens	2.37 - 3.79 : 1	EN14 (503-0059-00)	
long tele zoom lens	3.80 - 6.50 : 1	EN16 (503-0061-00)	
focusing distance	0.5 - 40m (see separate lens specifications)		
optical lens shift	vertical: ± 110%, horizontal: ± 90% (EN12 is on axis only)		
lens iris control	F/2.1 – 6.5 for all lenses, continuous		
general			
dimensions (dwh)	376 x 510 x 223 mm (excluding lens)		
weight	about 12.6 kg (excluding lens)		
conformances	CE, CSA "C/US", FCC Class A, CCC		
available colours	black metallic, silver metallic		
warranties	2 years, 500 hours or 90 days on lamp optional 3-year warranty, special conditions apply		

### Standardised bolt-on ceiling mount interface

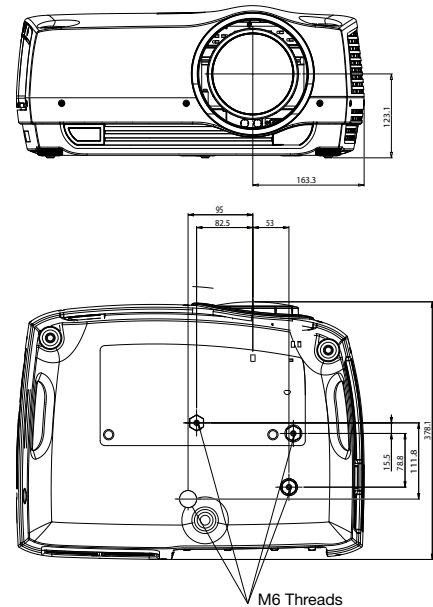

Distributed by: